



# Parkes East Public School - Home Learning Timetable



## Stage 2 – Term 2 Week 2

These are the required learning activities for your child for the next week.

Literacy	Numeracy	Additional subjects
<p><b>Spelling</b> – Complete the spelling activities in the table below or in your google classroom.</p> <ul style="list-style-type: none"> <li>- Complete the Reading Eggs activity sheet ( 3.10 or 4.10) below or in your google classroom.</li> </ul> <p><b>Writing</b> – 1. Keep a journal of your home learning this week. Write about a paragraph each day.</p> <p>2. Write a paragraph summarising the Hippopotamus.</p> <p>3. Complete Hippopotamus sheet.</p> <p><b>Reading</b> - Read for 15 minutes each day. Don't forget to log this on your Home Reading Card.</p> <ul style="list-style-type: none"> <li>- Read a book from the Premier's Reading Challenge and add it to your PRC log.</li> <li>- Reading Chapter 2 of the Hippopotamus Chapter 2 and complete activities.</li> <li>- Read the Hippopotamus sheet.</li> </ul> <p><b>Grammar</b>- Complete the Commas worksheet.</p>	<ul style="list-style-type: none"> <li>● Complete the measurement table below or in your google classroom.</li> <li>● Use a timer and time yourself writing out your 6 times tables each day. See if you can beat your time but remember it must be neat and readable.</li> <li>● Complete the measurement worksheets.</li> <li>● Log into Mathletics and complete this week's set task.</li> </ul>	<ul style="list-style-type: none"> <li>● <b>PDHealth- 'What Makes Us Healthy?'</b> Write and draw what you think makes us healthy. Consider food, exercise and any outside influences (e.g. pollution).</li> <li>● Search Youtube for "P.E with Joe" and complete his daily workout for 3 days. Teach another member of your family your favourite exercise.</li> <li>● <b>Art- Complete hippopotamus artwork.</b></li> <li>● <b>Music- African drumming rhythm.</b></li> <li>● Email your teacher about how your week has been going (if possible).</li> </ul>

Communication during this period is vital to the success of our home learning program. We encourage you to email your child's teachers with any concerns, questions or if you require feedback.

We hope you are enjoying your time at home and your family are all well.

Have a great week!

Stage 2 Teachers- Mrs House, Miss Parker, Miss Fitzpatrick, Mrs Dunford and Miss Patton.

**YEAR 4**  
**Spelling Words**  
**Term 2 Week 2**

Practice typing your spelling words in each column. Each column has a different way to write them. After you write your spelling words, write five sentences following the table using your spelling words.

	Normal	Colour	CAPITALS
unhappy			
unclear			
dislike			
misfit			
uneasy			
unwilling			
mislaid			
dislodge			
disown			
unstable			
unlawful			
discount			
disorder			
mismatch			
misunderstood			
unchanged			
disregard			
disinfect			
disloyal			
dismount			

## Sentences



# Prefixes – un, dis, mis

**List**

- unhappy
- unclear
- dislike
- misfit
- uneasy
- unwilling
- mislaid
- dislodge
- disown
- unstable
- unlawful
- discount
- disorder
- mismatch
- misunderstood
- unchanged
- disregard
- disinfect
- disloyal
- dismount

**1. Write the word.**

---

---

---

---

---

---

---

---

---

---

---

---

---

---

---

---

---

---

---

---

---

---

---

**2. Missing prefix.** Write the missing prefix.

- |                |             |
|----------------|-------------|
| ___ happy      | ___ changed |
| ___ understood | ___ clear   |
| ___ regard     | ___ lodge   |
| ___ willing    | ___ lawful  |
| ___ stable     | ___ order   |
| ___ like       | ___ easy    |
| ___ laid       | ___ fit     |
| ___ match      | ___ mount   |

**3. Chunks.** Rearrange the letters to make a list word.

- gar dis d re \_\_\_\_\_
- or dis der \_\_\_\_\_
- fi t mis \_\_\_\_\_
- law un ful \_\_\_\_\_
- mo dis t un \_\_\_\_\_
- y un s ea \_\_\_\_\_
- al loy dis \_\_\_\_\_
- sta le un b \_\_\_\_\_

**4. Sort the words.**

un	mis	dis



# Prefixes – un, dis, mis

**5. Underline the spelling mistakes.** Write the word correctly.

It was disclear how we would get there.

I mislike eating peas.

The weather report remained mischanged.

Tan has unlayed his homework.

Mum would misinfect the bench after cooking.

When Tilly was dishappy she would cry.

Fabian was diswilling to go to bed.

I had disunderstood the question.

---

---

---

---

---

---

---

---

## Challenge words

**6. Write the word.**

- unpopular \_\_\_\_\_
- disjointed \_\_\_\_\_
- disadvantage \_\_\_\_\_
- misadventure \_\_\_\_\_
- disqualify \_\_\_\_\_
- uncommon \_\_\_\_\_
- discontented \_\_\_\_\_
- unsatisfactory \_\_\_\_\_
- discomfort \_\_\_\_\_
- misfortune \_\_\_\_\_

**7. Hidden words.** Find the challenge words.

- dfvxssdisqualifydfdg \_\_\_\_\_
- gdxdvuncommonfgv \_\_\_\_\_
- dfdunsatisfactorydff \_\_\_\_\_
- dffgunpopularfgfbd \_\_\_\_\_
- gvcfdisadvantagedgf \_\_\_\_\_
- ffgdfdiscontenteddff \_\_\_\_\_
- sefdisjointedgvdsdgf \_\_\_\_\_
- gxdgvfdiscomfortxf \_\_\_\_\_
- tunemisfortunemis \_\_\_\_\_
- ventmisadventuretre \_\_\_\_\_

**8. Complete the sentence.**

Missing soccer practice meant Dan was at a \_\_\_\_\_.

I hoped that would not \_\_\_\_\_ me from the competition.

Rain is \_\_\_\_\_ at this time of year.

Mum gave me some more medicine to ease my \_\_\_\_\_.

Homework over the holidays is very \_\_\_\_\_ with the students.

He is very \_\_\_\_\_ with the judges harsh sentence.

Combine the sentences using a comma and a coordinating conjunction.  
(for and nor but or yet so)

Jim and Mary didn't want to be late. They ran.

---

You can have mangoes. You can have bananas.

---

Jenny had a beautiful kitten. She lost it.

---

Peter can make coffee. Jill can make scones.

---

I want to buy a new car. It is too expensive.

---

He could not go to the movies. He didn't have enough money.

---

Those shoes cannot be mine. They are too big for me.

---

She did her best. She did not pass the test.

---



## Hippopotamus

Hippopotamuses are found in Africa. The name hippopotamus means 'river horse' and is often shortened to hippo. The hippopotamus is generally considered the third largest land mammal (after the White rhinoceros and elephant).



Hippopotamuses spend a large amount of time in water such as rivers, lakes and swamps. Resting in water helps keep hippopotamuses temperature down. Hippopotamuses give birth in water.

Hippopotamuses have short legs, a huge mouth and a body shaped like a barrel. The closest relations of the hippopotamus are surprisingly whales and dolphins.

Although hippos might look a little chubby, they can easily outrun a human. Hippos can be extremely aggressive, especially if they feel threatened. They are regarded as one of the most dangerous animals in Africa. Hippos are threatened by habitat loss and poachers who hunt them for their meat and teeth.

A male hippopotamus is called a 'bull'. A female hippopotamus is called a 'cow'. A baby hippo is called a 'calf'. A group of hippos is known as a 'herd', 'pod', 'dale' or 'bloat'. Hippos typically live for around 45 years. Hippos eat mostly grass.

Watch these clips for more information:

<https://www.youtube.com/watch?v=0iYx5q5CudI>

<https://www.youtube.com/watch?v=AGYPvz9Dov8>

[https://www.youtube.com/watch?v=ks\\_P46IZCzk](https://www.youtube.com/watch?v=ks_P46IZCzk)

# HIPPOPOTAMUS REPORT SCAFFOLD

Use the information you have read or your own research to plan for an information report.

Common Name: Hippopotamus

Scientific Name:

Location/Habitat:

Physical Description:

General Information:

Labelled Diagram:



## African drumming - hippopotamus

The word elephant can be played on your drum like this:



See if you can make a rhythm to imitate how a hippopotamus moves.

See if you can make a rhythm to imitate the noise a hippopotamus makes.

## Hippo Art Activity



1. Draw a hippo onto a piece of white paper with an oil pastel/crayon.
2. After drawing the body, draw a water line through the middle of the hippo's head just below the eyes. Everything above this line was considered the sky and below; the murky water.
3. Colour the hippo's body using oil pastel/crayon.
4. Using water colours, paint the sky and water.
5. Using tissue paper, glue some reeds and fish onto the water.

Measurement

This week your task is to measure items within your home. Using a ruler or measuring tape to complete the task.

Item	cm	m
Bed		
TV		
Fridge		
Window		
Door		
Bath		
Book		
Pencil		
Drink Bottle		
Toy		

## Units of length – metres

We use metres to measure length.

There are 100 centimetres in a metre.

$$100 \text{ cm} = 1 \text{ m}$$

1 Convert these metres to centimetres:

a  $6 \text{ m} = \boxed{\phantom{000}} \text{ cm}$

b  $3 \text{ m} = \boxed{\phantom{000}} \text{ cm}$

c  $9 \text{ m} = \boxed{\phantom{000}} \text{ cm}$

2 Estimate and then measure the length and width of these objects:

Object		Estimate in metres	Measurement in metres
a classroom	length	m	m
	width	m	m
b whiteboard	length	m	m
	width	m	m
c desk	length	m	m
	width	m	m

3 Find out how tall each animal is to the nearest metre:

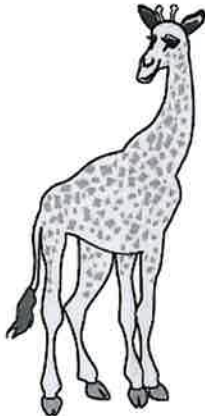

a  $\boxed{\phantom{000}} \text{ m}$

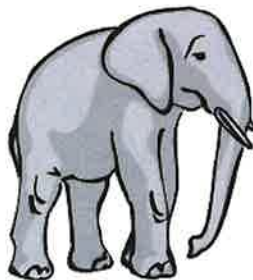

b  $\boxed{\phantom{000}} \text{ m}$

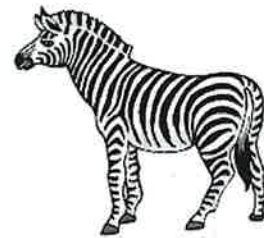

c  $\boxed{\phantom{000}} \text{ m}$

Measurement

Copyright © 3P Learning

D  
SERIES

1  
TOPIC

1

## Units of length – centimetres

We use centimetres to measure smaller units of length.

There are 100 centimetres in a metre.

100 cm = 1 m

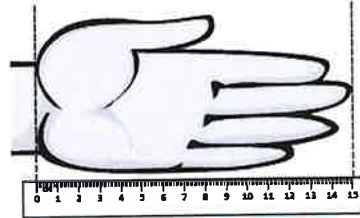

1 Record the lengths shown on this ruler in each box:

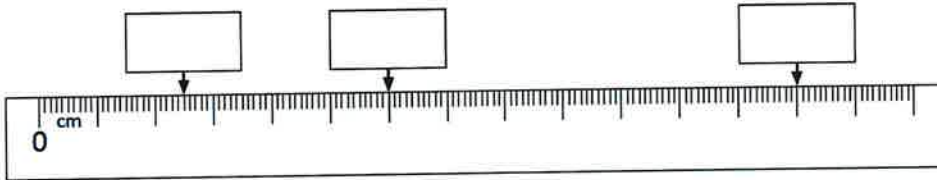

2 Use a ruler to draw the following lines. Start at the dot.

- a 7 cm •
- b 8 cm •
- c 11 cm •
- d 3 cm •

3 Measure these parts of your body with a piece of string. Lay the string beside a metre ruler to work out the correct measurement for each.

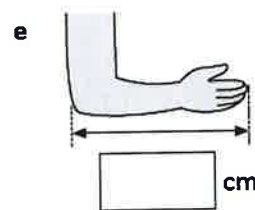
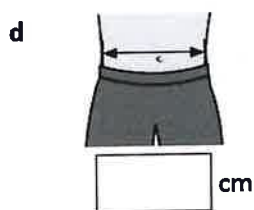
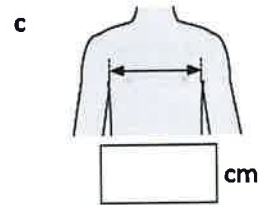
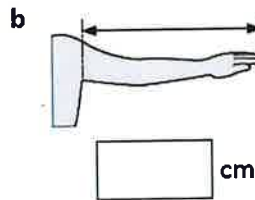
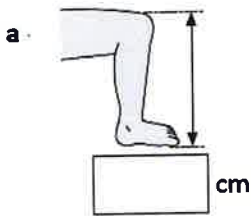

## Units of length – metres and centimetres

Often we will use both metres and centimetres when measuring length.  
This length of ribbon is 146 cm. This is 1 metre and 46 centimetres.



**1 Write these lengths in centimetres:**

- a 1 m 38 cm  cm    b 1 m 67 cm  cm    c 2 m 82 cm  cm  
 d 5 m 45 cm  cm    e 4 m 59 cm  cm    f 2 m 90 cm  cm

**2 Write these lengths as metres and centimetres:**

- a 217 cm  m  cm    b 391 cm  m  cm  
 c 462 cm  m  cm    d 113 cm  m  cm  
 e 835 cm  m  cm    f 194 cm  m  cm

**3 Work out the missing lengths that make up each metre:**

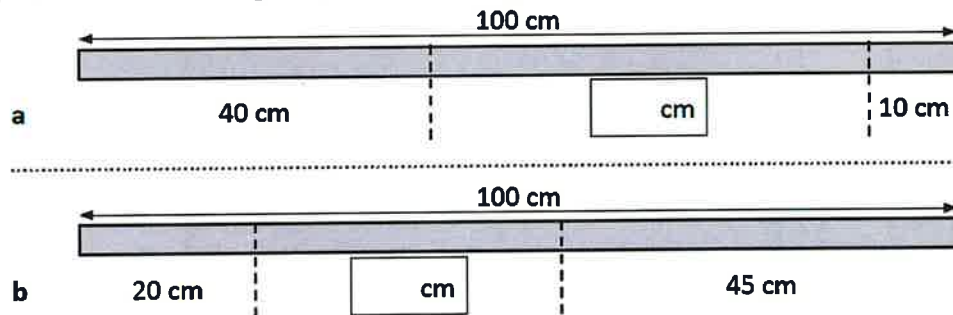

**4 Fill in the gaps using 'm' or 'cm':**

- a Hassan is 113  tall.    b The house is 5  taller than the car.  
 c Natasha only lives 79  from school.    d Leng measured her waist size and it was 64 .

## Units of length – length and decimal notation

- 3** In this activity, you are going to make a paper aeroplane to fly and mark the distance it has flown. You will need one sheet of A4 paper, a ball of string and a metre ruler.



- 1** Fold the sheet of A4 paper in half lengthwise. Crease the folded end. Unfold the paper and lay it on a flat surface.



- 2** Fold the right top corner to the centre line. Crease the diagonal fold. Repeat for the left top corner.

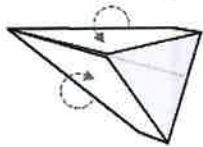

- 3** Fold the new right top corner to the centre line. Crease the folded end. Repeat for the new left top corner.

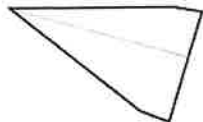

- 4** Turn the aeroplane over and fold the sheet lengthwise, inward, along the centre line. Crease the folded end.



- 5** Fold the top flap down so that its front touches the bottom of the 'plane'. Crease the folded end.



- 6** Turn the paper over, fold and crease the other flap as you did in step 5.

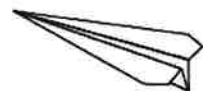

- 7** Lift the flaps to create the wings.

- a** Now that you have made a paper aeroplane, work in a small group to see who can throw their plane the furthest. Every time one of your group flies their aeroplane, place the string from the starting position to where it lands. Cut the string to the exact measurement and place it next to a metre ruler to work out the distance. Record your distances in the table below:

Name	Distance in centimetres	Distance in metres

- b** Whose aeroplane went the furthest? \_\_\_\_\_

Chapter 2.

Morris Lurie 

The Twenty-Seventh Annual African

# HIPPOTAMUS RACE



## Chapter Two Six Days To Go

Every morning, when it was still dark and ordinary hippopotamuses were still asleep, with the sky like velvet and the stars just starting to go out, Edward leapt from his bed, out of his pyjamas and into his bathing trunks. Wasting not a second, looking to neither left nor right, he ran for the river at the end of the garden, and dived in.

Splash!

First he swam eight kilometres down the river, going as fast as he could. Then he flipped over and came all the way back, trying to go even faster. His little bulgy eyes were closed tight — except for an occasional fast look just to make sure he was going in the right direction — while his huge mouth was open one minute, closed the next, sucking up enormous breaths. Over and over went his arms, cleaving a pathway through the water. And with each stroke of an arm, he gave a powerful kick with a leg.

Whoosh! Whoosh!

And no sooner was he back at the garden than he immediately began twenty minutes of vigorous exercises, touching his toes, running on the spot,

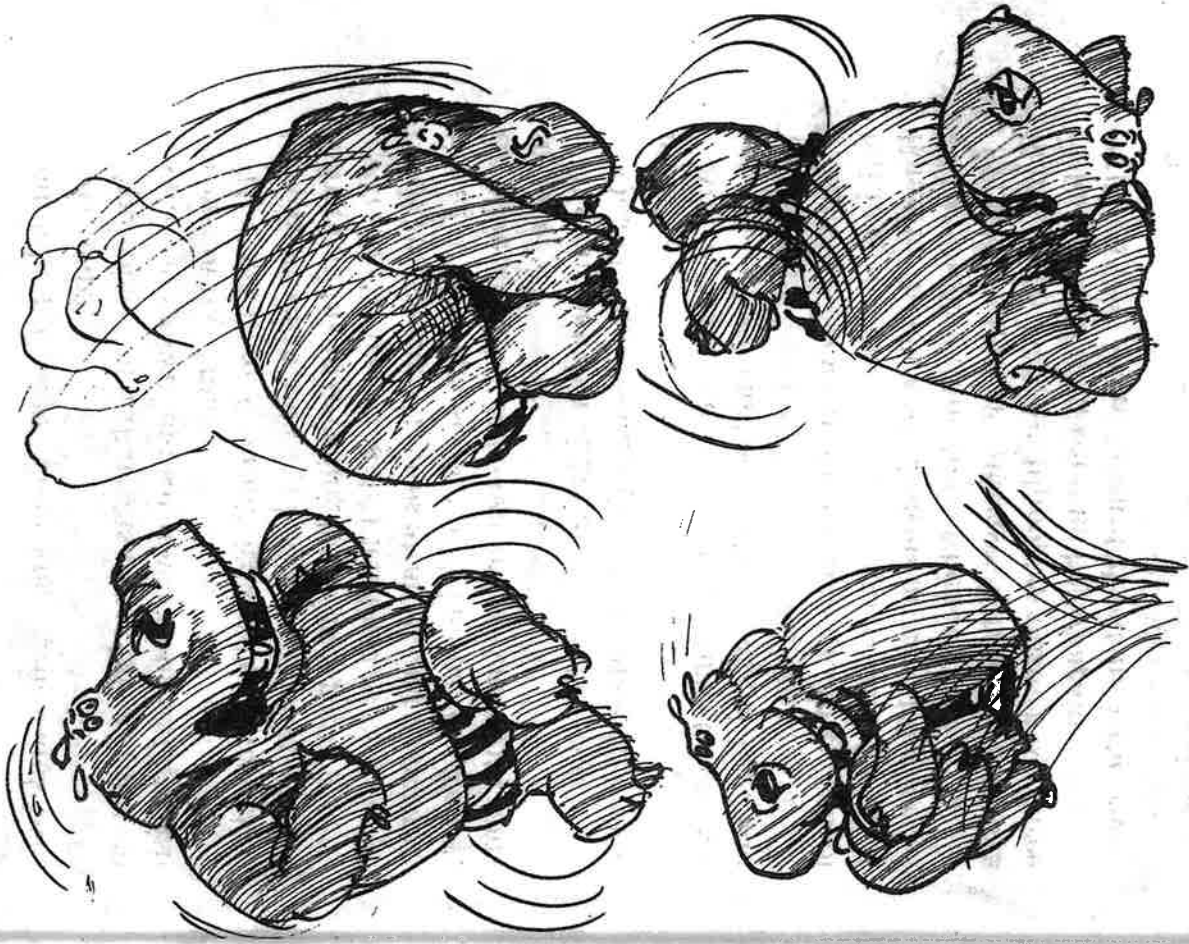



windmills, press-ups, deep knee bends and two-legged leaps.

And then, when that was done, Edward put on his dressing gown and sat down to breakfast with the rest of the family.

'How did it go, Champ?' Edward's father asked him. Ever since Edward had started training, his father had taken to calling him 'Champ'.

'Terrific!' Edward said. 'I feel fine.'

And how hungry he was after all that exercising. Six eggs! Four glasses of milk! Ten pieces of toast, each piece thickly buttered and covered with marmalade.

'Watch that diet, Champ,' his father said.

'Quickly, now,' said Edward's mother, 'It's time for school.'

And Edward had just enough time to change into his school clothes, grab his school bag, and run off.

Back he came at twelve o'clock, when school finished for the day, and hippopotamuses went home for lunch and to sleep in the afternoon — a very sensible thing to do when it's hot.

His grandfather allowed Edward only one hour's sleep — most hippopotamuses have three or four — and then training began again.

This time, when Edward dived into the river,

his grandfather jumped on to a bicycle, and as Edward swam down the river, his grandfather bicycled along the bank, shouting out instructions through a megaphone.

'Keep your head down! Keep your head down! Use your legs! Use your legs!'

He shouted everything twice, because he knew it was hard to hear when you were swimming fast with your eyes shut tight and your mouth opening and closing, sucking up enormous quantities of air.

'Push with that left leg! Push with that left leg!' he shouted, his legs flying on the bicycle pedals.

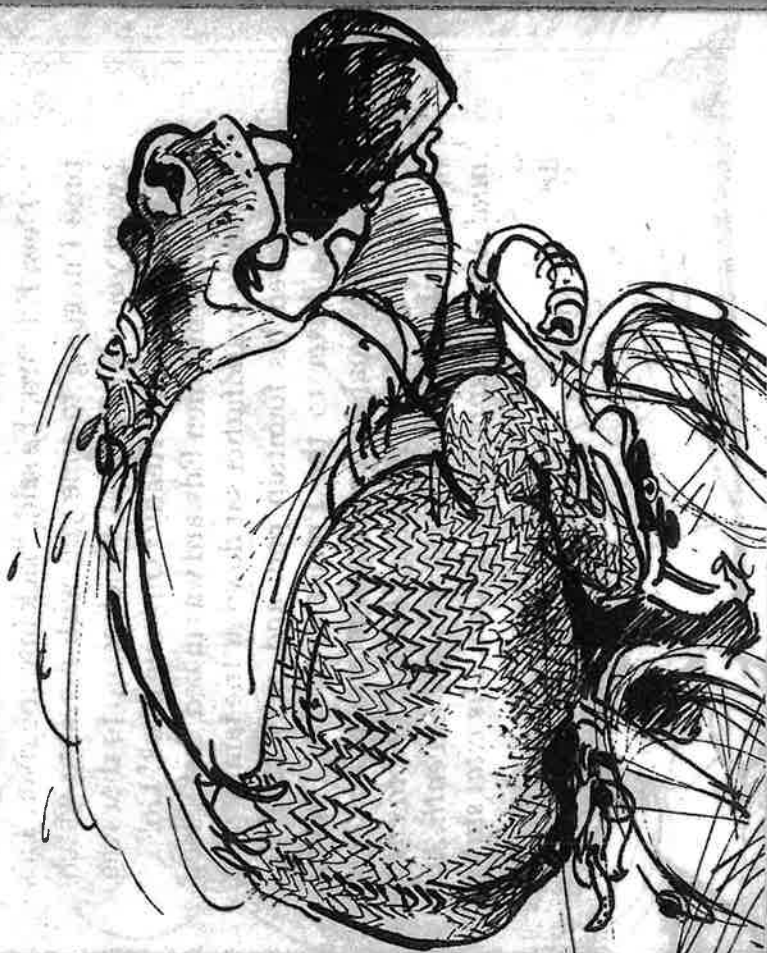

'That'll do! That'll do! Come out! Come out! Take a rest. Whew! You're too fast for me.'

Poor old Theodore. It was a long time since he'd done anything as strenuous as bicycling up and down a river bank, shouting instructions through a megaphone. He felt a bit wobbly in the legs.

'How's it going, Champ?' said Edward's father.

'Fine!' said Edward. 'I feel terrific.'

'He's too fast for me,' said Edward's grandfather. 'I'm out of breath. Just a minute. Lots to do. Lots to do. Lotsssss...'

Edward's grandfather was asleep.

But an hour later he was back again, as keen as ever.

'Now, Edward,' he said, 'back into the river. This time I'm going to time you with my stop watch. I want you to swim five kilometres, up to that tree, as fast as you can. Ready? On your mark! Go!'

That night, when Edward was in bed, fast asleep, Edward's grandfather sat down at the family desk, unscrewed his fountain pen, and, very carefully, wrote a letter to the President of the Twenty-Seventh Annual African Hippopotamus Race.

'Dear President,' he wrote. 'I would like to enter my grandson Edward in the Twenty-Seventh Annual African Hippopotamus Race. His vital statis-

tics are as follows: he is one and a half metres high. He is three metres long. His weight is two and a half tonnes and two kilograms. His age: eight last birthday. I believe him to be a true champion, but that you will be able to judge for yourself. He is being trained by yours truly.'

And here he signed his name.

There!



And so the days went, each day beginning with the *buzz-buzz* of Edward's alarm clock.

Into the river!

And there was so much to learn.

One afternoon, Edward's grandfather began to show Edward how to do a proper racing dive.

'Head down! Head down!' he called. 'On your mark! On your mark!'

Edward tucked his head down. Up went his arms. He hooked his toes over the edge of the riverbank, for extra leverage. He took a deep breath, and held it. He leant forward, and waited for the signal to dive in.

Seconds passed. Edward, tense as a spring, waited and waited. Where was the signal?

'Oh!' cried Edward, who could lean forward no longer, and before he could help himself, in he toppled.

Splash!

Up shot a huge wave of water, waking up Edward's grandfather.

'What happened?' said Edward's grandfather. 'Oh dear, I fell asleep.'

'Do you want me to try it again?' asked Edward.

'Um,' said Edward's grandfather, who still felt sleepy. 'No. This time I want you to swim eight

kilometres down the river, and eight kilometres back. As fast as you can. Ready? Go!

And while Edward was swimming down the river as fast as he could, Edward's grandfather took a nap under a shady tree. Edward's training really was taking it out of him. It was a long time since he had had to do so much.

But Edward's father, taking a stroll along the river bank, woke him up.

'Have you seen the paper?' he said. 'Look at this. Seems there are going to be a record number of entries this year.'



'Wait till I get my spectacles,' said Edward's grandfather. 'There. Let me see. Ah. Um. *Record amuses have so far entered in the Twenty-Seventh Annual African Hippopotamus Race*. Well, well. Very interesting.'

Meanwhile, Edward's grandmother was knitting a pair of racing trunks, navy blue in colour, with a white belt, for Edward to wear for the Twenty-Seventh Annual African Hippopotamus Race. Click, click went her knitting needles, as the racing trunks took shape.

On and on went Edward's training. He loved all of it.

Except for one thing.

There were his school friends, playing games and going for snoozes, doing anything they wanted to do, and here he was, swimming up and down the river, up and down, up and down.

How long it was since he had played games with his friends!

One day, when he was feeling very low, who should come crashing through the weeds to watch him swim but Humphrey and Tad, William and Jeffrey, Benjamin and Luke, his very best friends.

'That's the style, Edward!' they cried, cheering and waving. 'You show them! Hooray! Hooray!'

22



Edward felt so happy, seeing all his friends, and hearing them clapping and shouting encouragement, that he struck out in the river, going faster than ever before, so fast that his grandfather, who was on his bicycle, fell right behind and finally gave up altogether and came to rest alongside a tree.

'That hippopotamus is the fastest I've ever seen,' said Edward's grandfather. 'He's faster than me. And I'm on a bicycle.'

23

One day, when Edward climbed out of the river, after yet another eight kilometre swim, there was his father.

'A letter's just arrived,' said Edward's father. 'It's for Theodore.'

'It's from the President of the Twenty-Seventh Annual African Hippopotamus Race,' said Edward's grandfather.

'Dear Sir,' he read. *'We are pleased indeed to accept your grandson Edward for the Twenty-Seventh Annual African Hippopotamus Race. The race will be held, as it is held every year, on the First of June. I look forward to seeing you and your grandson on that date. Best Wishes. Good Luck. Yours Sincerely, The President of the Twenty-Seventh Annual African Hippopotamus Race.'*

'Gosh!' said Edward, blinking his eyes and breathing rapidly through his huge mouth, which had fallen wide open. 'Six days to go!'

Six days  
And h  
Edwar  
of eight  
twenty r  
Meanv  
yellow b  
For m  
looking f  
needed s  
five in h  
saw seem  
London,

A red c  
He did  
right, so  
take hom  
'I'll pa  
much hap  
When h  
painting i  
all the se  
upstairs p

Name \_\_\_\_\_

**‡ CHAPTER 2 ‡**  
**SIX DAYS TO GO**

1. When did Edward start his training each day?

---

---

---

2. Why do you think Edward kept his eyes closed whilst he was swimming?

---

---

---

---

3. Why does Edward's father call him 'Champ'?

---

---

---

4. In the box below draw Edward's breakfast after training.

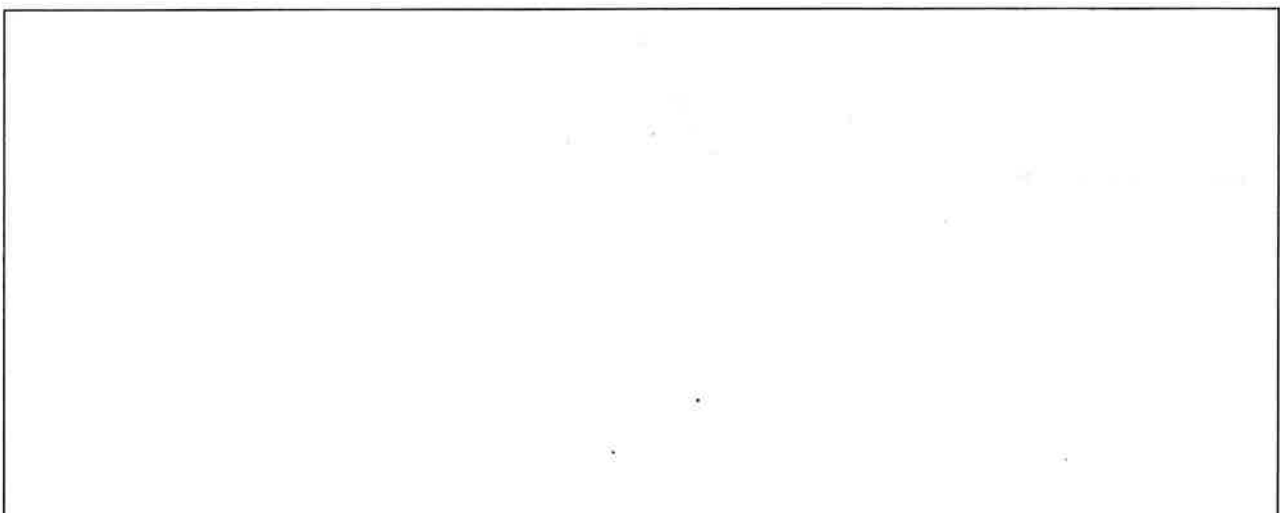

5. What time does Edward finish school? Why?

---

---

---

6. What does Edward's grandfather do to help Edward with his training?

---

---

---

7. How is Edward entered into the Twenty – Seventh Annual African Hippopotamus Race?

---

---

---

8. Why does Edward need to learn to do a proper racing dive?

---

---

---

9. Why do you think Edward's grandfather finds training Edward so tiring when he doesn't have to do the work himself?

---

---

---

10. What is the important information Edward's father sees in the newspaper?

---

---

---

11. In the box below draw the racing trunks Edward's grandmother knits for him.

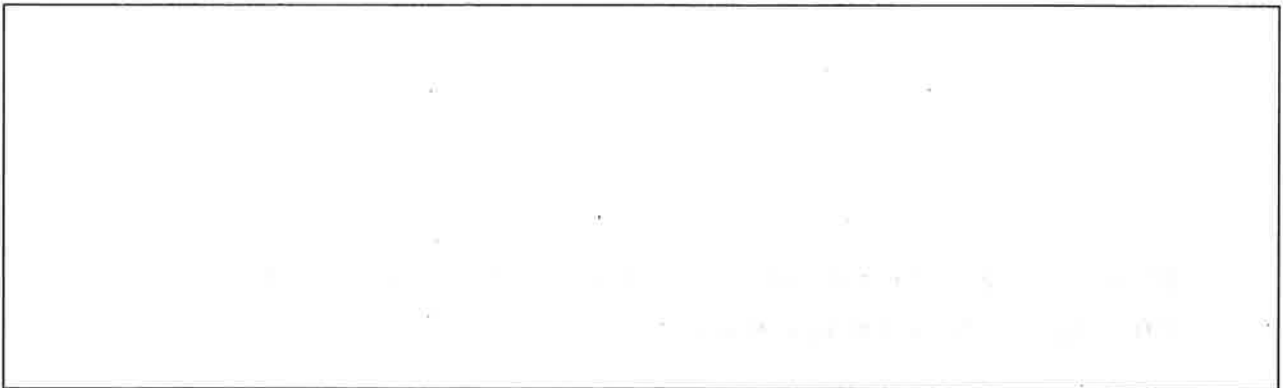

12. What is the one thing Edward doesn't enjoy about training?

---

---

---

---

13. How do Edward's friends help him with his training?

---

---

---

14. How well do you think Edward will do in the race? Why?

---

---

---

---



Name \_\_\_\_\_

# ‡ RACE POSTER ‡

Design a poster for the Twenty – Seventh Annual African Hippopotamus Race to let everyone know all about the race so they can enter.

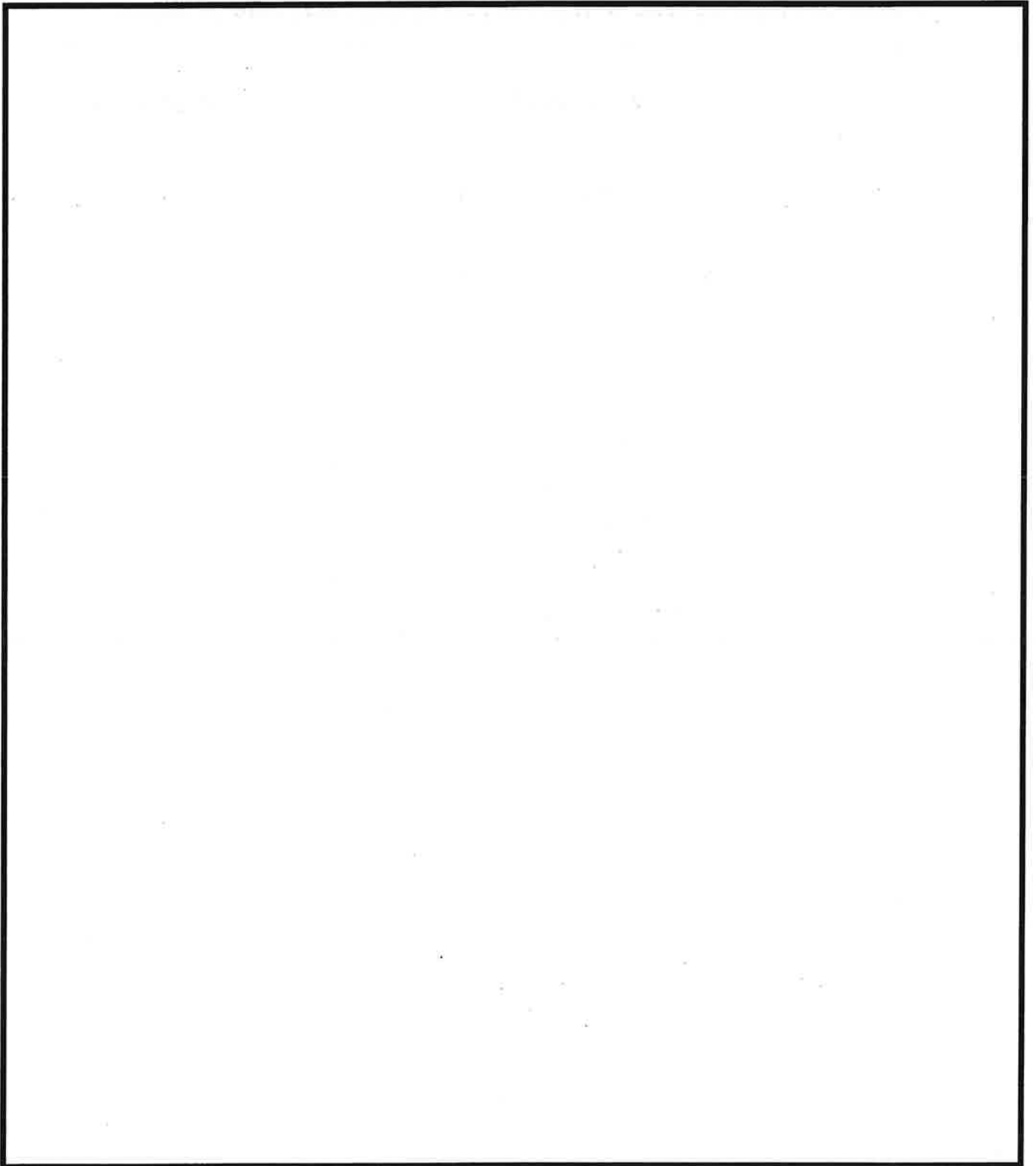

Name \_\_\_\_\_

## ‡ EDWARD'S TRAINING ‡

Edward has to train very hard for the race, not just swimming in the river but he also has to do other exercises as well. Using the table below make up your own training schedule. Get some friends together, agree on how long you will do each activity and then get started! How will you go doing Edward's training?

<b>TIME LIMIT</b>	<b>ACTIVITY</b>	<b>MY RESULTS</b>
1 MINUTE	TOUCHING YOUR TOES	
	RUNNING ON THE SPOT	
	WINDMILLS	
	PRESS - UPS	
	DEEP KNEE BENDS	
	TWO - LEGGED LEAPS	

Draw or describe how your group went with Edward's training

Name \_\_\_\_\_

## ⚡ MAKING CONNECTIONS ⚡

Edward is looking forward to competing in the Twenty – Seventh Annual African Hippopotamus Race. Have you ever competed in a race? Are you able to make connections with this storyline to experiences you have had or read about?

### Making Connections – Text To Text

Do you know of any other stories where someone has competed in a race? Describe the connections between the stories.

---



---



---



---



---



---

### Making Connections – Text To Self

Have you ever competed in a race? What sort of race was it? How did you go? Describe what happened and how you felt.

---



---



---



---



---



---



---



---



---



---

